

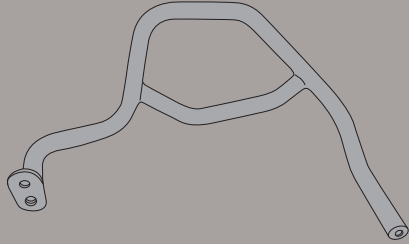

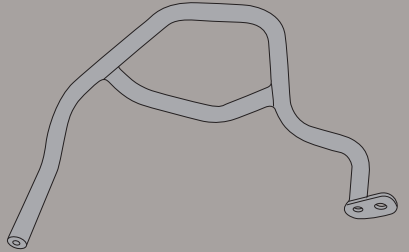



TNH5124 - KNH5124

PARAMOTORE SPECIFICO - SPECIFIC ENGINE GUARD - PARE-CARTER SPECIFIQUE - SPEZIFISCHER STURZBÜGEL - DEFENSA DE MOTOR ESPECÍFICA - PARAMOTOR ESPECÍFICO

BMW R1200GS (2013 -2017) / BMW R1250GS (2019 -2020)

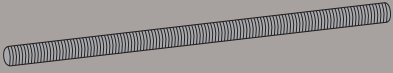
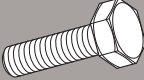
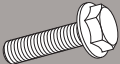
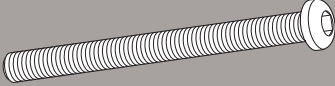
N°	Descrizione	Caratteristiche	Codice	Quantità	
1	Paramotore - Engine Guard Pare-carter - Sturzbuegel Defensa De Moto - Paramotor	-	TNH5124SXV	1 (Sx)	
2	Paramotore - Engine Guard Para-carter - Sturzbuegel Defensa De Moto - Paramotor	-	TNH5124DXV	1(Dx)	
3	Supporto - Support - Support Halteung - Soporte - Apoio	-	GNB1918V	1	
4	Rondella - Washer Rondelle - Scheibe Arandela - Arruela	-	GL3636V	2	
5	Piastrina - Plate - Platine Parrilla - Platte - Base	-	GL3277V	1	
6	Barra Filettata - Threaded Bar - Tige Filetee - Gewinde Stange - Barra Roscada	-	V955	1	
7	Vite - Screw Vis - Schraube Tornillo - Parafuso	TES M10x25	1025TES	2	
8	Vite - Screw Vis - Schraube Tornillo - Parafuso	TECF M8x20	820TECF	2	
9	Vite - Screw Vis - Schraube Tornillo - Parafuso	TBEI M8x75	875TBEI	2	
10	Rondella - Washer Rondelle - Scheibe Arandela - Arruela	Ø12	12RON	2	

TNH5124 - KNH5124

PARAMOTORE SPECIFICO - SPECIFIC ENGINE GUARD - PARE-CARTER SPECIFIQUE - SPEZIFISCHER STURZBÜGEL - DEFENSA DE MOTOR ESPECÍFICA - PARAMOTOR ESPECÍFICO

BMW R1200GS (2013 -2017) / BMW R1250GS (2019 -2020)

N°	Descrizione	Caratteristiche	Codice	Quantità	
11	Rondella - Washer Rondelle - Scheibe Arandela - Arruela	Ø10	10RON	2	
12	Rondella - Washer Rondelle - Scheibe Arandela - Arruela	-	814RON	2	
13	Supporto - Support - Support Halierung - Soporte - Apoio	-	V882	2	
14	Dado - Bolt - Ecrou Mutter - Tuerca	Dado Autobloccante Flangiato M8	8DADIFN	2	
15	Coprivite - Screw Cap Cache Vis - Stopsschraube Tapa Tornillo - Capa do Parafuso	-	17COP	2	

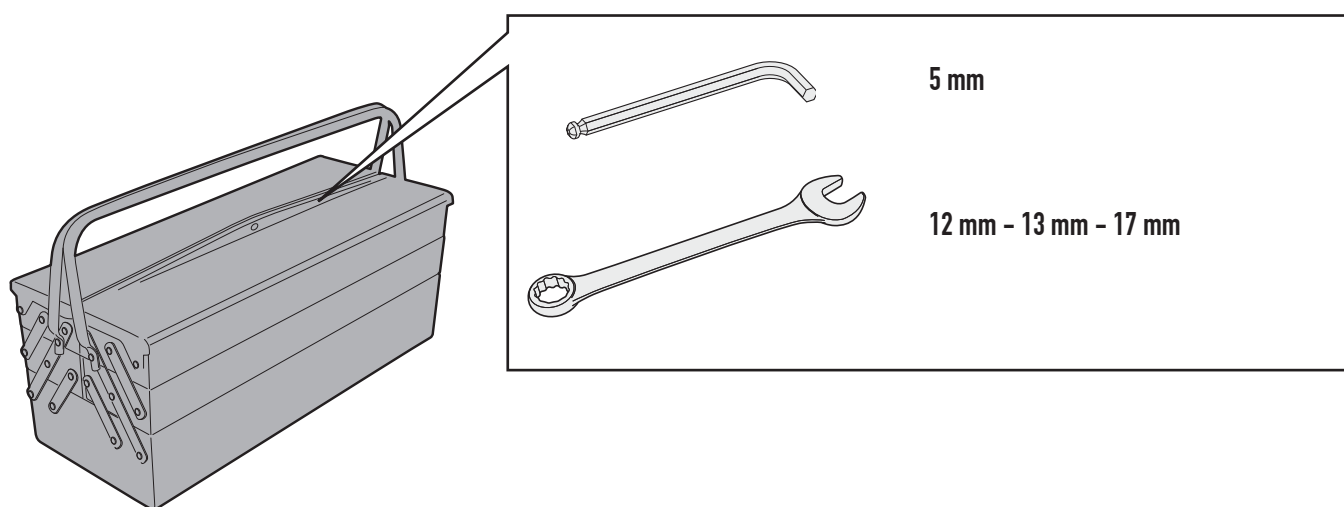

TNH5124 - KNH5124

PARAMOTORE SPECIFICO - SPECIFIC ENGINE GUARD - PARE-CARTER SPECIFIQUE - SPEZIFISCHER STURZBÜGEL - DEFENSA DE MOTOR ESPECÍFICA - PARAMOTOR ESPECÍFICO

BMW R1200GS (2013 -2017) / BMW R1250GS (2019 -2020)

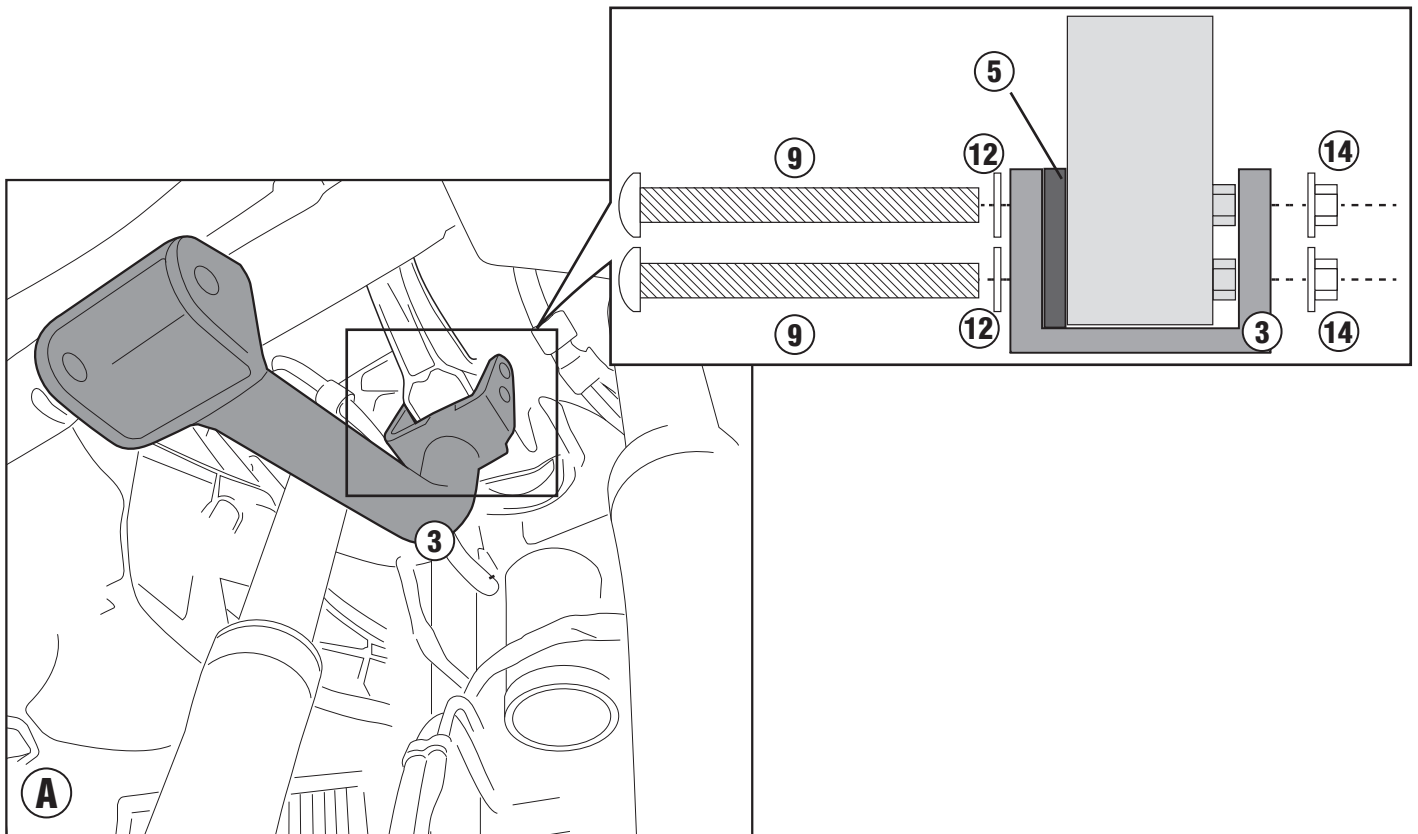
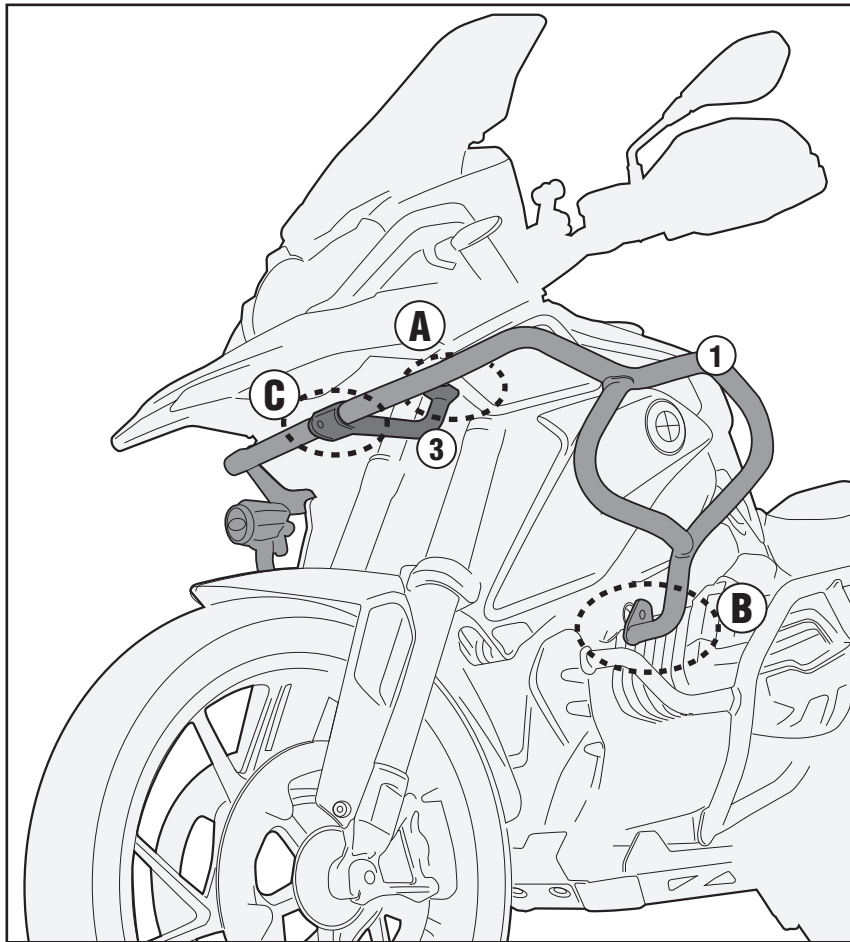

TNH5124 - KNH5124

PARAMOTORE SPECIFICO - SPECIFIC ENGINE GUARD - PARE-CARTER SPECIFIQUE - SPEZIFISCHER STURZBÜGEL - DEFENSA DE MOTOR ESPECÍFICA - PARAMOTOR ESPECÍFICO

BMW R1200GS (2013 -2017) / BMW R1250GS (2019 -2020)

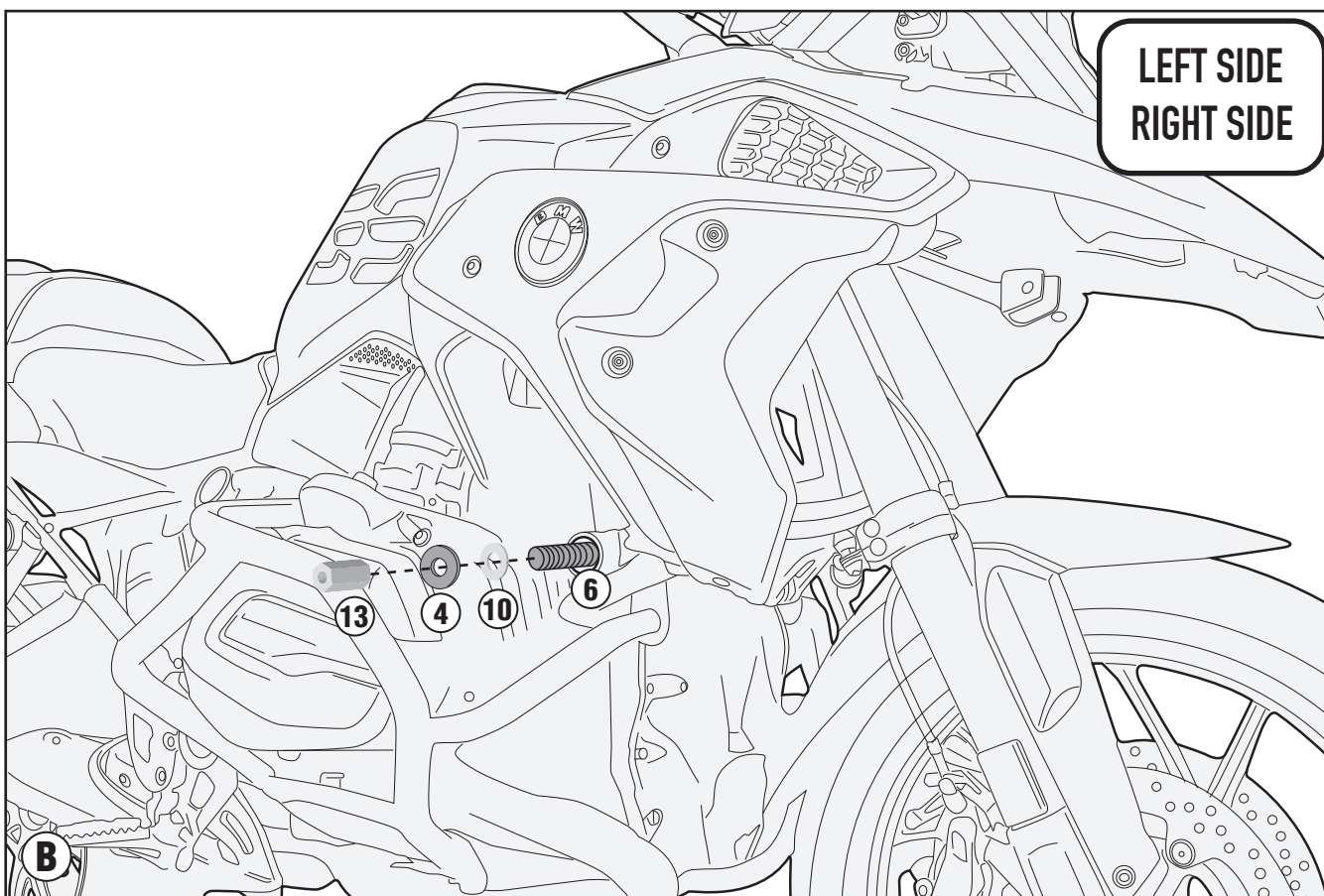
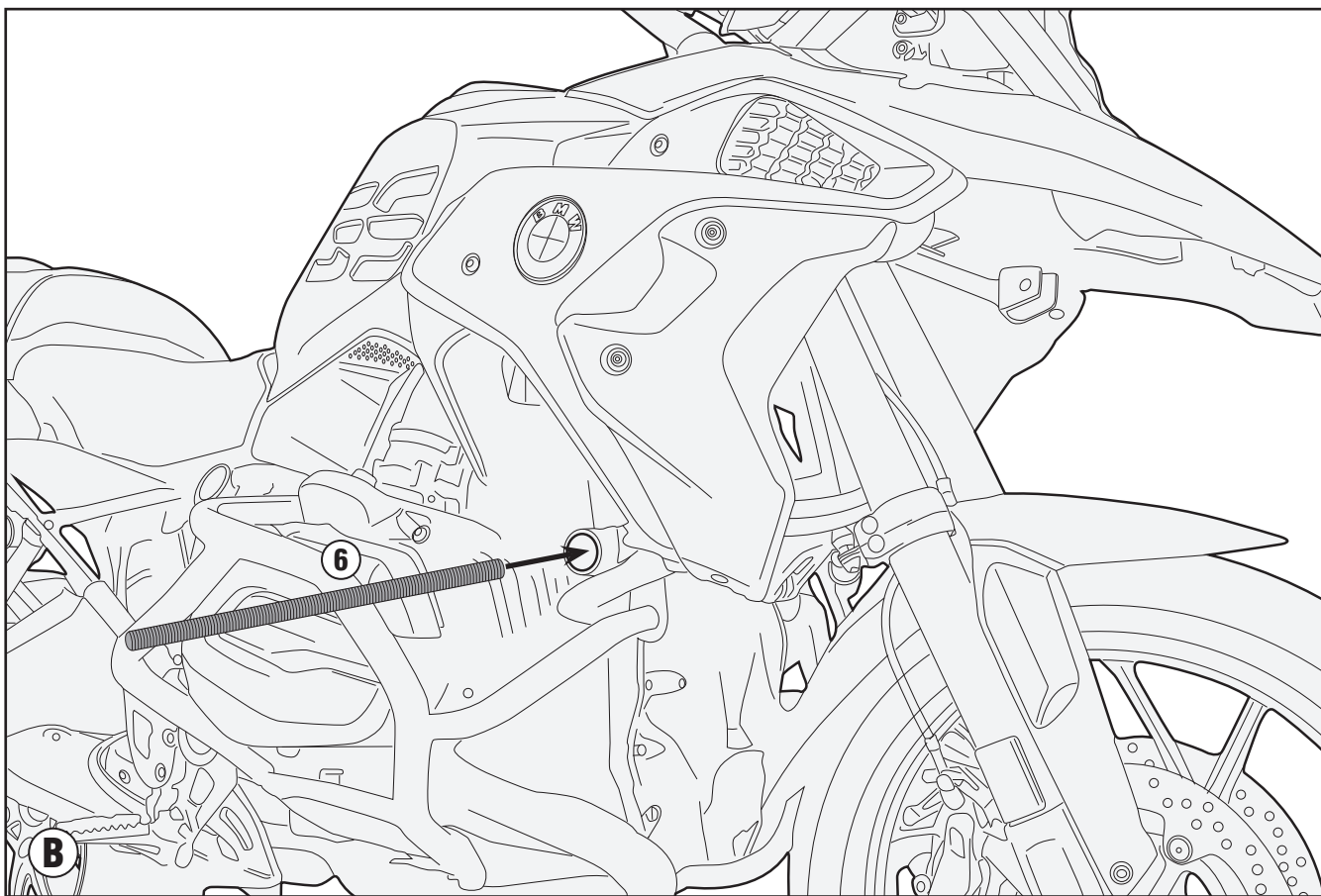

ISTRUZIONI DI MONTAGGIO - MOUNTING INSTRUCTIONS
INSTRUCTIONS DE MONTAGE - BAUANLEITUNG
INSTRUCCIONES DE MONTAJE - INSTRUÇÕES DE MONTAGEM

TNH5124 - KNH5124

PARAMOTORE SPECIFICO - SPECIFIC ENGINE GUARD - PARE-CARTER SPECIFIQUE - SPEZIFISCHER STURZBÜGEL - DEFENSA DE MOTOR ESPECÍFICA - PARAMOTOR ESPECÍFICO

BMW R1200GS (2013 -2017) / BMW R1250GS (2019 -2020)

